

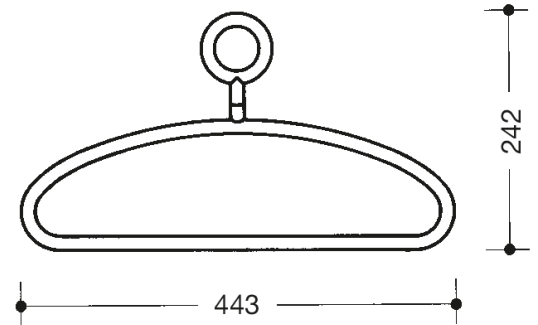

Similar picture

















Dimensions in mm

Properties

Coat and trouser hanger

- made of high-quality polyamide, according to HEWI colour chart
- diameter 15 mm, 242 x 443 mm, fits on rail diameter 33 mm
- with rotatable eye, with 90° locking points

Colours / Surfaces

 24 (orange)	 55 (aqua blue)	 86 (sand)	 97 (light grey)
 33 (ruby red)	 72 (may green)	 18 (mustard yellow)	 98 (signal white)
 36 (coral)	 74 (apple green)	 92 (anthracite grey)	 99 (pure white)
 50 (steel blue)	 84 (umber)	 95 (stone grey)	 90 (jet black)