

# SEACHROME

Seachrome Corporation  
1906 East Dominguez Street  
Long Beach, California 90810  
Phone: (800) 955-2476  
Fax: (800) 444-3380

Description:

GSBB-360-QCR  
36" Bariatric Straight Grab Bar  
(Satin Stainless Finish)

Customer:

Customer Part #

12-11-2020

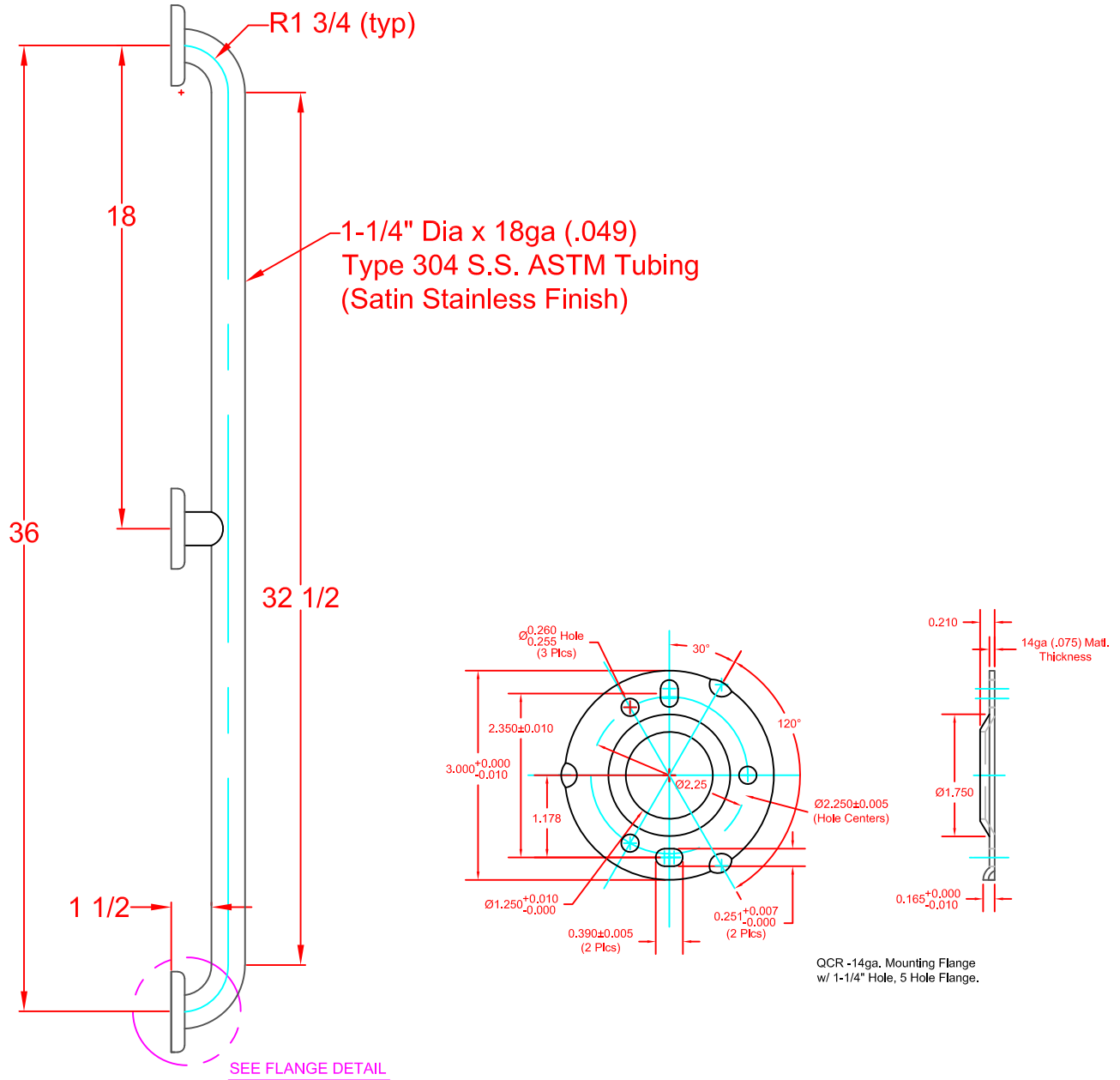

## Proprietary & Confidential

This drawing and the information contained herein is the property of Seachrome Corporation and shall not be reproduced, copied, or disclosed in whole or in part, or used in manufacturing, or for any other purpose without the written permission of Seachrome Corporation.

Hardware Package Includes:  
(9) #10 x 2-1/2" Phillips Pan Head  
Sheet Metal Screw