

SEACHROME

Seachrome Corporation
1906 East Dominguez Street
Long Beach, California 90810
Phone: (800) 955-2476
Fax: (800) 444-3380

Description:

GSBB-520-QCR
52" Bariatric Straight Grab Bar
(Satin Stainless Finish)

Customer:

Customer Part #

12-14-2020

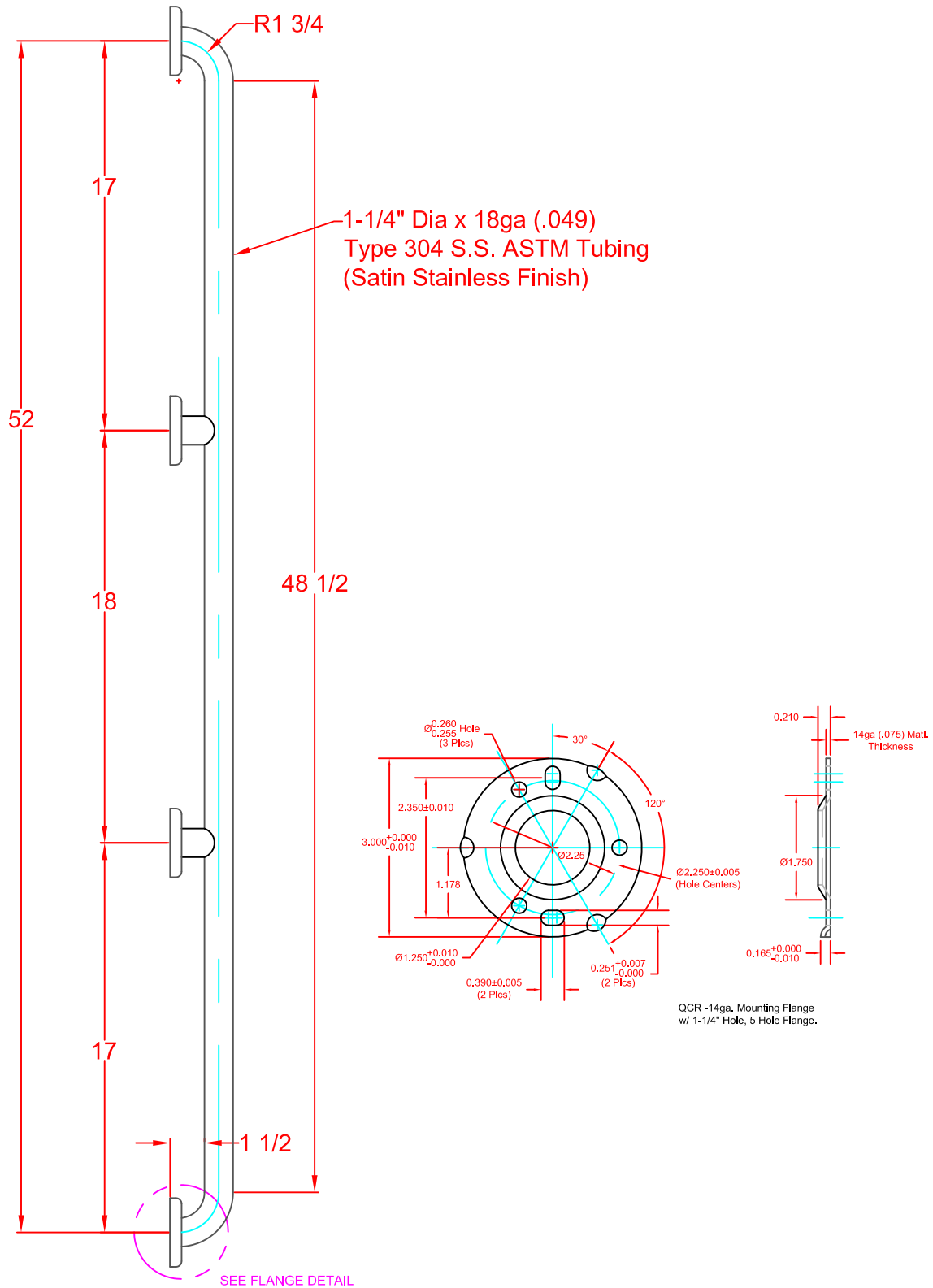

Proprietary & Confidential

This drawing and the information contained herein is the property of Seachrome Corporation and shall not be reproduced, copied, or disclosed in whole or in part, or used in manufacturing, or for any other purpose without the written permission of Seachrome Corporation.

Hardware Package Includes:
(12) #10 x 2-1/2" Phillips Pan Head
Sheet Metal Screw